



Thermocycler GEN2

Instruction Manual



Opentrons Labworks Inc.

Edition
GEN2, January 2023

Table of Contents

Product and Manufacturer Description	3
– Product Description	
– Manufacturer Description	
Safety Information and Regulatory Compliance	4
– Safe Use Specifications	
– Safety Warning Labels	
– Instrument Safety Warnings	
– Standards Compliance	
Product Specifications	11
– Model Number	
– Included Parts	
– Physical Specifications	
– Temperature Profile	
– LED Status Light	
Setup	13
– Ventilation Requirements	
– Setup Steps	
– Plate Latching	
– Emergency Lid Opening	
Maintenance	20
– Cleaning	
– Repair	
– Warranty	
Étiquettes d'avertissement de sécurité	21

Product and Manufacturer Description

PRODUCT DESCRIPTION

The Opentrons Thermocycler Module GEN2 provides on-deck, fully automated thermocycling. The module enables automation of upstream and downstream workflow steps.

MANUFACTURER DESCRIPTION

Opentrons Labworks Inc

45-18 Ct Square W

Long Island City, NY 11101

Safety Information and Regulatory Compliance

Opentrons strongly recommends that you follow the safe use specifications listed in this section and throughout this manual.

Note: The Thermocycler heats and cools very quickly during operation.

SAFE USE SPECIFICATIONS

Input and Output Connections

The Thermocycler has the following power input requirements, which are met by the included power supply.

Warning: Do **not** replace the power supply cable unless at the direction of Opentrons Support.

Power Supply (AC):

- **Voltage:** 100–240 V
- **Frequency:** 50/60 Hz
- **Current:** 8.5–5 A
- **Overvoltage:** Category II

Safety Information and Regulatory Compliance

Environmental Conditions

The Thermocycler should only be used indoors, on a sturdy, dry, flat horizontal surface. The Thermocycler must be installed in a low-vibration environment with stable ambient conditions (e.g., keep the Thermocycler away from direct sunlight or HVAC systems that may cause significant temperature or humidity changes).

Environmental conditions for recommended use, acceptable use, and storage vary:

	Recommended for System Operation	Acceptable for System Operation	Storage and Transportation
Ambient Temperature	+20 to +25 °C	+2 to +40 °C	-10 to +60 °C
Relative Humidity	30–80%, non-condensing	30–80%, non-condensing (below 30 °C)	10–85%, non-condensing (below 30 °C)
Altitude	Approximately 500 m above sea level	Up to 2000 m above sea level	Up to 2000 m above sea level

Opentrons has validated the Thermocycler's performance in the conditions recommended for system operation, and operation in those conditions should provide optimal results. The Thermocycler is safe to use in conditions acceptable for system operation, but results may vary. The device should not be powered on or used in conditions outside of those bounds. The storage and transportation conditions only apply when the device is completely disconnected from power and other equipment.

Safety Information and Regulatory Compliance

Warning: Setting the Thermocycler to hold a temperature below the ambient temperature for a long time can cause condensation to develop in and on the device. **Do not set the plate temperature below the ambient temperature for more than 2 hours**, as the resulting condensation could affect performance or damage the module.

If you notice condensation on the Thermocycler's plate after use, remove any labware from the module and use the Opentrons App to set a temperature of 40 °C until the condensation is no longer visible.

Software Requirements

The Thermocycler requires version 6.2.0 or newer of the Opentrons App and OT-2 robot server.

You can download the Opentrons App for Windows, macOS, or Ubuntu at <https://opentrons.com/ot-app/>.

Labware Compatibility

The Thermocycler is compatible with full-skirted, 96-well PCR plates. Opentrons' performance specifications are based on use with Opentrons Tough PCR Plates, which you can purchase at <https://shop.opentrons.com>.

Safety Information and Regulatory Compliance

SAFETY WARNING LABELS

Warning labels posted on the Opentrons Thermocycler and in this manual warn you about sources of potential injury or harm. Table 1 provides a key to each safety warning label.

NOTE: French safety warnings are listed in the back of the manual. (**REMARQUE:** Les avertissements de sécurité en français se trouvent à la fin du manuel.)



CAUTION: Risk of danger! This symbol identifies instrument components that pose a risk of personal injury or instrument damage if improperly handled. Wherever this symbol appears, please consult the manual for further information on safe handling before proceeding.



CAUTION: Risk of electrical shock! This symbol identifies instrument components that pose a risk of electrical shock if handled improperly.



CAUTION: Hot surface! This symbol identifies instrument components that, if handled improperly, pose a risk of personal injury due to high temperature.



CAUTION: Pinch point! This symbol identifies instrument components (namely, the automated lid) which can pose risk of personal injury due to its closing mechanism. Please do not reach near the lid when it is in operation.

Table 1. Instrument safety warning labels.

Safety Information and Regulatory Compliance

INSTRUMENT SAFETY WARNINGS

Warning labels posted on the Opentrons Thermocycler refer directly to the safe use of the instrument, as described in Table 2.

NOTE: French safety warnings are listed in the back of the manual.
(**REMARQUE:** Les avertissements de sécurité en français se trouvent à la fin du manuel.)



Warning about risk of harm to body or equipment. Operating the Opentrons Thermocycler before reading this manual poses a risk of personal injury or instrument damage. Only qualified laboratory personnel should operate this instrument.



Warning about risk of harm to body or equipment from electrical shock. Do not attempt to repair or remove the outer case of the Opentrons Thermocycler or its power supply unless directed by Opentrons Support. Failure to do so puts you at risk of electrical shock.



Warning about risk of burning. The Opentrons Thermocycler generates enough heat to cause serious burns. Wear safety goggles or other eye protection at all times during operation. Always ensure the sample block returns to idle temperature before opening the lid and removing samples. Always allow maximum clearance to avoid accidental burns. Unplug the unit after use, if possible.



Warning about risk of explosion. The Opentrons Thermocycler sample blocks can become hot enough during the course of normal operation to cause liquids to boil and explode.

Table 2. Instrument safety warning labels.

Safety Information and Regulatory Compliance

STANDARDS COMPLIANCE

The Thermocycler has been tested and found to be in compliance with all applicable requirements of the following safety and electromagnetic standards:

Safety

- IEC/UL/CSA 61010-1 Safety Requirements for Electrical Equipment for Measurement, Control, and Laboratory Use – Part 1: General Requirements
- IEC/UL/CSA 61010-2-010 Particular Requirements for Laboratory Equipment for the Heating of Materials

Electromagnetic Compatibility

- EN/BSI 61326-1 Electrical Equipment for Measurement, Control and Laboratory Use – EMC Requirements – Part 1: General Requirements
- EN 55011 Industrial, Scientific and Medical Equipment – Radio-Frequency Disturbance Characteristics – Limits and Methods of Measurement
- FCC 47CFR Part 15 Subpart B Class A: Unintentional Radiators
- IC ICES-003 Spectrum Management and Telecommunications – Interference-Causing Equipment Standard – Information Technology Equipment (Including Digital Apparatus)

Safety Information and Regulatory Compliance

FCC Warnings and Notes

Warning: Changes or modifications to this unit not expressly approved by Opentrons could void the user's authority to operate the equipment. This device complies with part 15 of the FCC Rules. Operation is subject to the following two conditions: (1) This device may not cause harmful interference, and (2) this device must accept any interference received, including interference that may cause undesired operation.

Note: This equipment has been tested and found to comply with the limits for a Class A digital device, pursuant to part 15 of the FCC Rules. These limits are designed to provide reasonable protection against harmful interference when the equipment is operated in a commercial environment. This equipment generates, uses, and can radiate radio frequency energy and, if not installed and used in accordance with the instruction manual, may cause harmful interference to radio communications. Operation of this equipment in a residential area is likely to cause harmful interference in which case the user will be required to correct the interference at their own expense.

Canada ISED Compliance

Canada ICES-003(A) / NMB-003(A)

This product meets the applicable Innovation, Science and Economic Development Canada technical specifications.

Le présent produit est conforme aux spécifications techniques applicables d'Innovation, Sciences et Développement économique Canada.

CISPR 11 Class A

Caution: This equipment is not intended for use in residential environments and may not provide adequate protection to radio reception in such environments.

Product Specifications

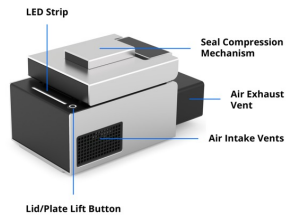
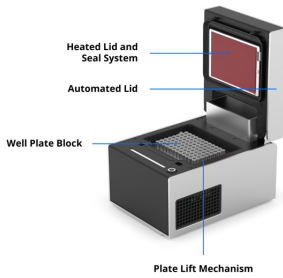

MODEL NUMBER

TCG2

INCLUDED PARTS

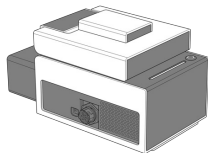

(1) Thermocycler

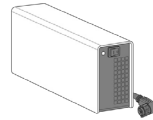

(1) Power Supply and Power Supply Connector

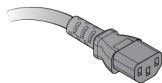

(1) Power Cable

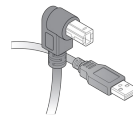

(1) USB Cable

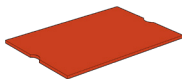

(5) Rubber Automation Seals

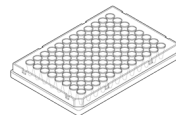

(10) Opentrons Tough PCR Plates

Product Specifications

PHYSICAL SPECIFICATIONS

- **Dimensions:**
 - Lid open: 244.95 mm L x 172 mm W x 310.1 mm H
 - Lid closed: 244.95 mm L x 172 mm W x 170.35 mm H
- **Weight:** 8.4 kg (including rear duct)

TEMPERATURE PROFILE

- Thermal block temperature range: 4–99 °C
- Thermal block maximum heating ramp rate: 4.25 °C/s between ambient and 95 °C
- Thermal block maximum cooling ramp rate: 2.0 °C/s between 95 °C and ambient
- Lid temperature range: 37–110 °C
- Lid temperature accuracy: ± 1 °C

LED STATUS LIGHT

The Thermocycler has a strip of LEDs that can display four colors: white, orange, red, and blue. The possible module conditions indicated by the light strip are:

LED COLOR AND BEHAVIOR	MODULE CONDITIONS
Solid white	Idle
Flashing orange	Error
Pulsing red	Changing to hot temperature (>23 °C)
Solid red	Holding at hot temperature (>23 °C)
Pulsing blue	Changing to cool temperature (<23 °C)
Solid blue	Holding at cool temperature (<23 °C)

Warning: The status LED will display solid white whenever the module is not actively heating or cooling, regardless of its current temperature. It may still be hot to the touch.

Setup

VENTILATION REQUIREMENTS

To allow for sufficient fan output from the Thermocycler, at least 20 cm / 8 inches of empty space is required between the unit and a wall.

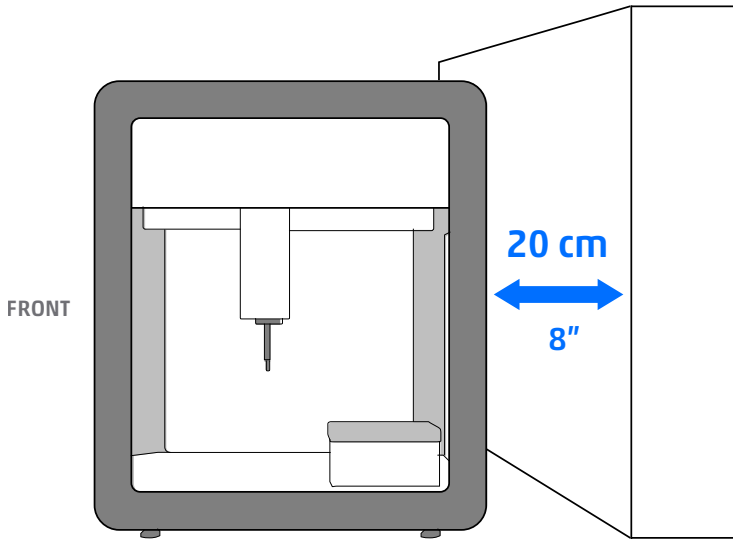

Setup

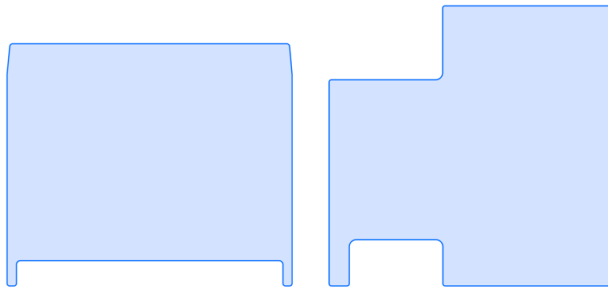
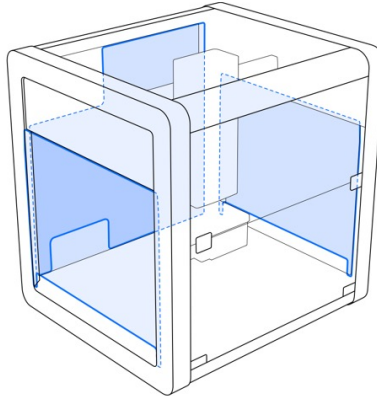

2x Side Panels

1x Rear Panel

Also for ventilation, and to provide enough space for the power and USB cables to connect to the module, Opentrons advises using the OT-2 side and rear panels shown below:

Note: These panels are included with newer models of the OT-2. They only need to be replaced on older models of the OT-2.

To add new panels to your OT-2:

Setup

SETUP STEPS

Deck Placement and Connection

- 1 Carefully place the Opentrons Thermocycler in deck slots 7, 8, 10, and 11. Lift the module carefully, using two hands (the module weighs 8.4 kg, which is quite heavy for its size).

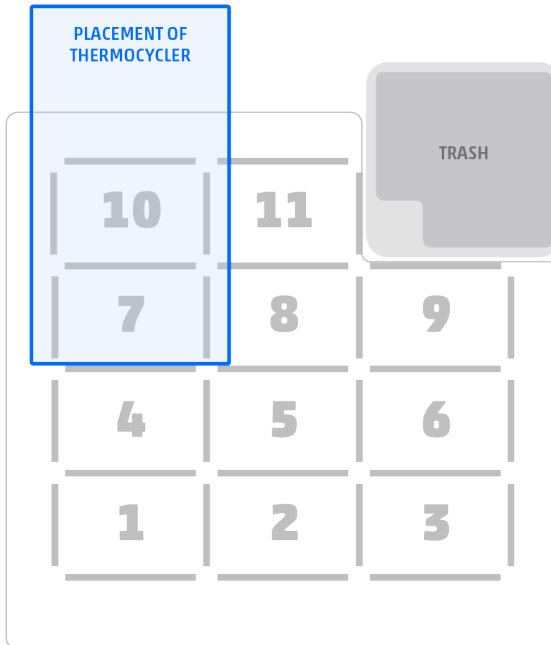

Setup

2

Connect the Thermocycler to the OT-2 and power supply by plugging in the USB cable and screwing the power cable into the unit as shown. Be sure to route the cables through the opening in the polycarbonate side panel.

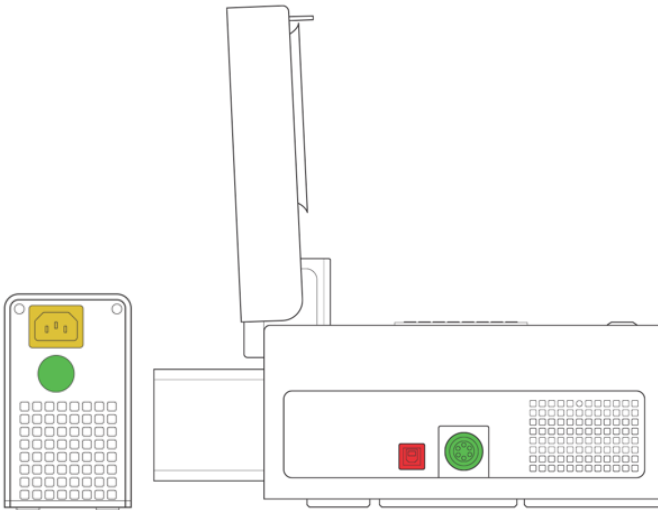

- Connect the USB cable to the module and an open USB port at the back of the robot
- Connect the power supply connector to the Thermocycler and then screw it on for safety
- Connect the power cable to the back of the power supply and the wall outlet

Setup

3

Once everything is connected, power on the OT-2 and the Thermocycler power supply. If you see a white light on the Thermocycler, it is powered on. You can open and close the lid of the Thermocycler by pressing the round button on the front.

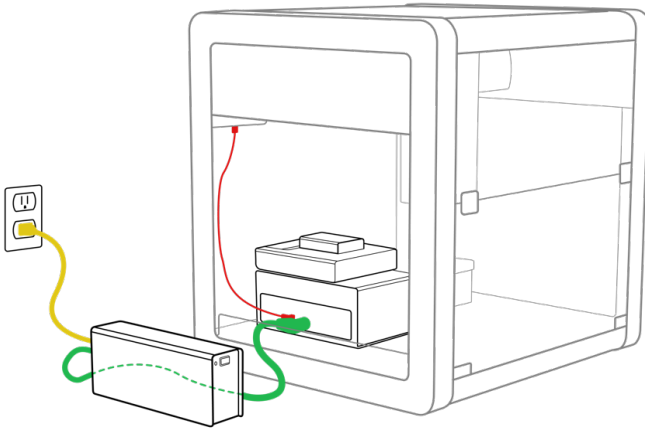

Setup

Rubber Automation Seals

Your Opentrons Thermocycler comes with 5 rubber automation seals to help reduce evaporation. Each seal must be sterilized before use and can be used for several runs. You should check the state of the seal after each run and replace it if needed. Worn or damaged seals may result in increased evaporation of samples.

4

Apply a seal to the lid of the module, not directly to the plate, to enable pipetting access.

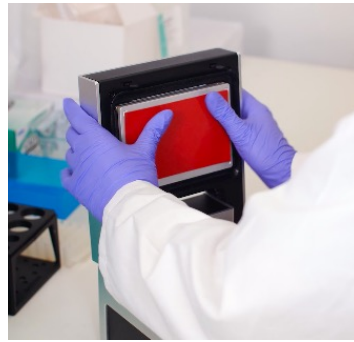

5

After applying the seal, wipe it with a 1:10 dilution of bleach and let it dry. Wipe it down with molecular biology grade water and let it dry again.

Note: Seals must be sterilized before your first Thermocycler run. Thermocycler seals cannot be autoclaved.

Setup

PLATE LATCHING

Thermocycler GEN2 does not include a plate latch, and latching plates with a hard polycarbonate frame should not be necessary. If your application requires softer plates and you have problems with plates sticking to the seal when opening the lid, contact Opentrons Support to obtain a plate latch mechanism.

EMERGENCY LID OPENING

In case of a power outage, connectivity issue, or other electrical failure, the Thermocycler lid may not open. If you need to manually open it to retrieve your samples:

- 1 Turn the unit off (if possible) and unplug it.
- 2 Insert the included hex wrench into the circular slot on the left side of the module, as shown.
- 3 Push the wrench inward 25 mm / 1 inch.
- 4 Manually lift the lid.

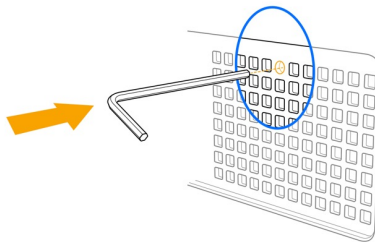

Maintenance

CLEANING

Before cleaning the Thermocycler, unplug the power and USB cables. Do not clean the temperature indicator LED strip, power button, power input port, or USB port of the Thermocycler.

All other surfaces are compatible with:

- 10% bleach solution
- 70% ethanol
- 99% isopropyl alcohol

Spray one of these cleaners onto a paper towel and use it to wipe the following parts of the Thermocycler:

- PCR top plate
- Lid heating plate
- Module housing/body
- Lid plastic housing
- Sheet metal housing
- Rubber seal

When done, wipe down these parts with a dry paper towel.

Avoid introducing cleaning substances into the USB port or power port. Never douse or spray the module directly with cleaner.

Repair

Users should not attempt to service or repair the Thermocycler Module themselves. If you have concerns about your module's performance or require repairs, please contact Opentrons Support.

Warranty

All hardware purchased from Opentrons is covered under a 1-year standard warranty. Opentrons warrants to the end-user of the products that they will be free of manufacturing defects due to part quality issues or poor workmanship and also warrants that the products will materially conform to Opentrons' published specifications.

Étiquettes d'avertissement de sécurité

Les étiquettes d'avertissement affichées sur le Thermocycler Opentrons et dans ce manuel vous avertissent des sources potentielles de blessures ou de dommages. Une clé pour chaque étiquette d'avertissement de sécurité est référencée dans le tableau 1.



ATTENTION: Risque de danger! Ce symbole identifie les composants de l'instrument qui présentent un risque de blessure ou de dommage pour l'instrument s'ils ne sont pas manipulés correctement. Où que ce symbole apparaisse, veuillez consulter le manuel pour plus d'informations sur la sécurité du traitement avant de continuer.



ATTENTION: Risque d'électrocution! Ce symbole identifie les composants de l'instrument présentant un risque de choc électrique en cas de manipulation incorrecte.



ATTENTION: Surface chaude! Ce symbole identifie les composants de l'instrument présentant un risque de blessure corporelle en raison d'une température de chauffage excessivement élevée s'ils sont manipulés de manière incorrecte.



ATTENTION: Pincer! Ce symbole identifie les composants de l'instrument (à savoir le couvercle automatisé) qui peuvent présenter un risque de blessure en raison de son mécanisme de fermeture. S'il vous plaît ne pas atteindre près du couvercle lorsqu'il est en cours d'utilisation.

Tableau 1. Étiquettes d'avertissement de sécurité des instruments.

Étiquettes d'avertissement de sécurité

AVERTISSEMENTS DE SÉCURITÉ DES INSTRUMENTS

Les étiquettes d'avertissement apposées sur le Thermocycleur Opentrons font directement référence à l'utilisation en toute sécurité de l'instrument, comme expliqué dans le tableau 2.



Avertissement sur les risques de lésions corporelles ou corporelles. Utiliser le thermocycleur Opentrons avant de lire ce manuel présente un risque de blessure ou de dommage aux instruments. Seul un personnel de laboratoire qualifié doit utiliser cet instrument.



Avertissement concernant le risque de blessure corporelle ou physique par électrocution. Ne tentez pas de réparer ou de retirer le boîtier extérieur du thermocycleur Opentrons ni son alimentation, sauf indication contraire de l'équipe de support technique d'Opentrons. Ne pas le faire vous expose à un risque de choc électrique.



Avertissement sur le risque de brûlure. Le thermocycleur Opentrons génère suffisamment de chaleur pour causer de graves brûlures. Porter des lunettes de protection ou une autre protection oculaire en tout temps pendant le fonctionnement. Assurez-vous toujours que le bloc d'échantillons retourne à la température d'inactivité avant d'ouvrir le couvercle et de retirer les échantillons. Toujours autoriser un dégagement maximal pour éviter les brûlures accidentelles. Débranchez l'appareil après utilisation, si possible.



Avertissement sur le risque d'explosion. Les blocs d'échantillons Opentrons Thermocycleur peuvent devenir suffisamment chauds au cours de leur fonctionnement normal pour provoquer l'ébullition et l'explosion de liquides.

Tableau 2. Étiquettes d'avertissement de sécurité des instruments.

